

AVERON TEA-HA TIMER



TNE-10N Analog 220AC User's manual

AVERON EQUIPMENT CO.,LTD.

1/843 MOO17 TAMBOL KUKOD,LAM LUK KA DISTRICT,PATHUMTHANI.12130

TEL.+662 061 1015 FAX:+662 063 2214

 +668 6344 7741,+668 6344 7714,+668 1312 1112



<https://www.averon-equipment.com>

Description

1. กล่องอลูมิเนียมหล่อ

เนื่องจาก PCB ของ TNE ตั้งเวลาอยู่ในอลูมิเนียม กล่องหล่อขึ้นรูปทำเพื่อความสะดวกในการกันน้ำ และฝุ่นพิสูจน์อักษร

2. การออกแบบที่ประหยัดประกอบด้วยหน้าที่สำคัญ เฉพาะสำหรับตัวเก็บฝุ่น

3. การออกแบบภายนอก

มีจอแสดงผลด้านนอกเช่นหลอดไฟ LED และระบบไฟฟ้าหลัก สวิตช์.

SPEC	TNE TIMER
➤ สัญญาณเอาต์พุต	ไฟฟ้า
➤ ลักษณะ	บอร์ดเท่านั้น
➤ ประเภทการควบคุม	อนาล็อก
➤ กรองขัง	อลูมิเนียมหล่อ NEMA 4
➤ แม็กซ์ เอาต์พุต	10p, 20p
➤ เวลา Pulse	ลงทะเบียนปริมาณ
➤ Dwell Time	ลงทะเบียนปริมาณ
➤ แหล่งจ่ายไฟ	AC85 ~ 240V / 50 ~ 60Hz
➤ ฟิวส์	2A
➤ ความดัน	-
➤ การดำเนินงาน อุณหภูมิ	320 ~ 60 °C (ถ้าไม่ใช่เงื่อนไขการแช่แข็ง)
➤ ประเภทขั้ว	1.25 4Y

Timers

TNE TIMER

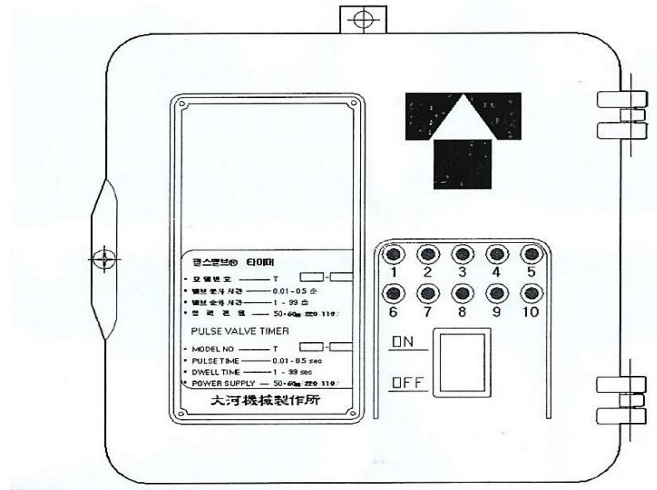

Dimension

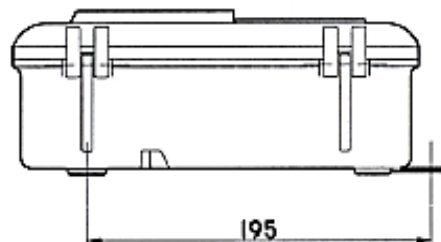
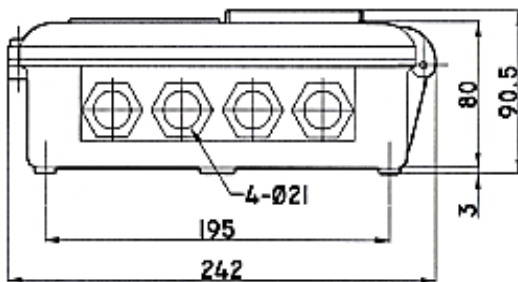
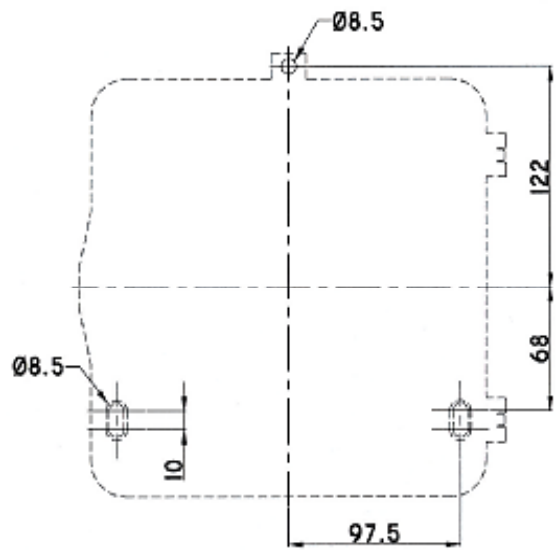
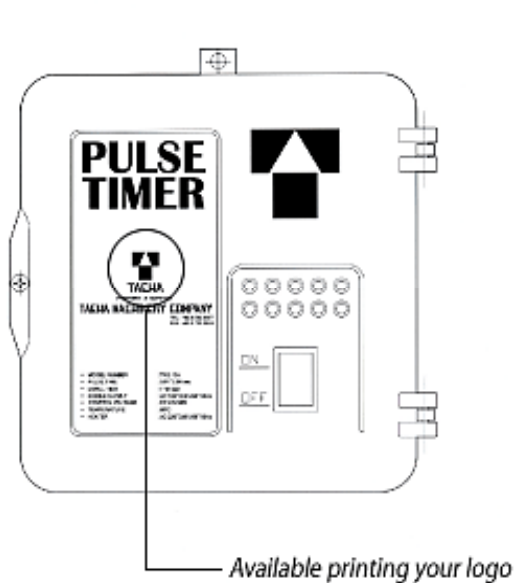

1. Installation method of Timer

1.1 Notion

Installation method of Timer will be changeable by operating method of Pulse Valve (remote type and integral type)

1.2 Selection and Installation of Timer

1.2.1 Selection and Installation of Timer for integral type Pulse Valve

Integral type need to select and install Timer Which has not Solenoid Valve. You will install installation place which has 150 m distance from walkway. It is easy to operate, maintain, and control the system (Pulse timer, Dwell time, DIP switch) You will manufacture installation place of Timer by Appendix 7.6.3 Timer drawing. Installation Bolt size is M6-30L. If the installation place is thick, you can lengthen the size.

1.2.2 Selection and Installation of Timer for remote type Pulse Valve

For remote type Pulse Valve, select and install the Timer includes the built-in Solenoid coil. We suggest that Timer is positioned to minimize the tube length, and preferably to ensure that no tubes are longer 5m-this avoids excess air build-up which in turn could slow down the operation of diaphragm.

1.2.3 The terminal wiring and tubing

- Wiring the valve solenoid coil to the Timer for the Integral the Integral type valve.
- Tubing each Pulse Valve to the Timer for the Remote type valve.

1.3 The terminal wiring for the Integrated type valve

1.3.1 The method of terminal wiring for DIN Socket

First of all, connect the contacts of the DIN socket to the terminal wiring to avoid short circuits caused by moisture and/or dust

- 1) Remove the DIN socket cover after unscrewing the bolts upper DIN Socket using by screw driver. Be sure to fasten the bolts.
- 2) Remove the square terminal block inside of DIN socket using by small-type driver.
- 3) Unfasten the nuts on the bottom parts of the DIN socket and put the wire into the inside of DIN socket as following diagram.
- 4) Connect the wire to terminal 1 and 2
- 5) Reassemble the DIN Socket in the reverse order.

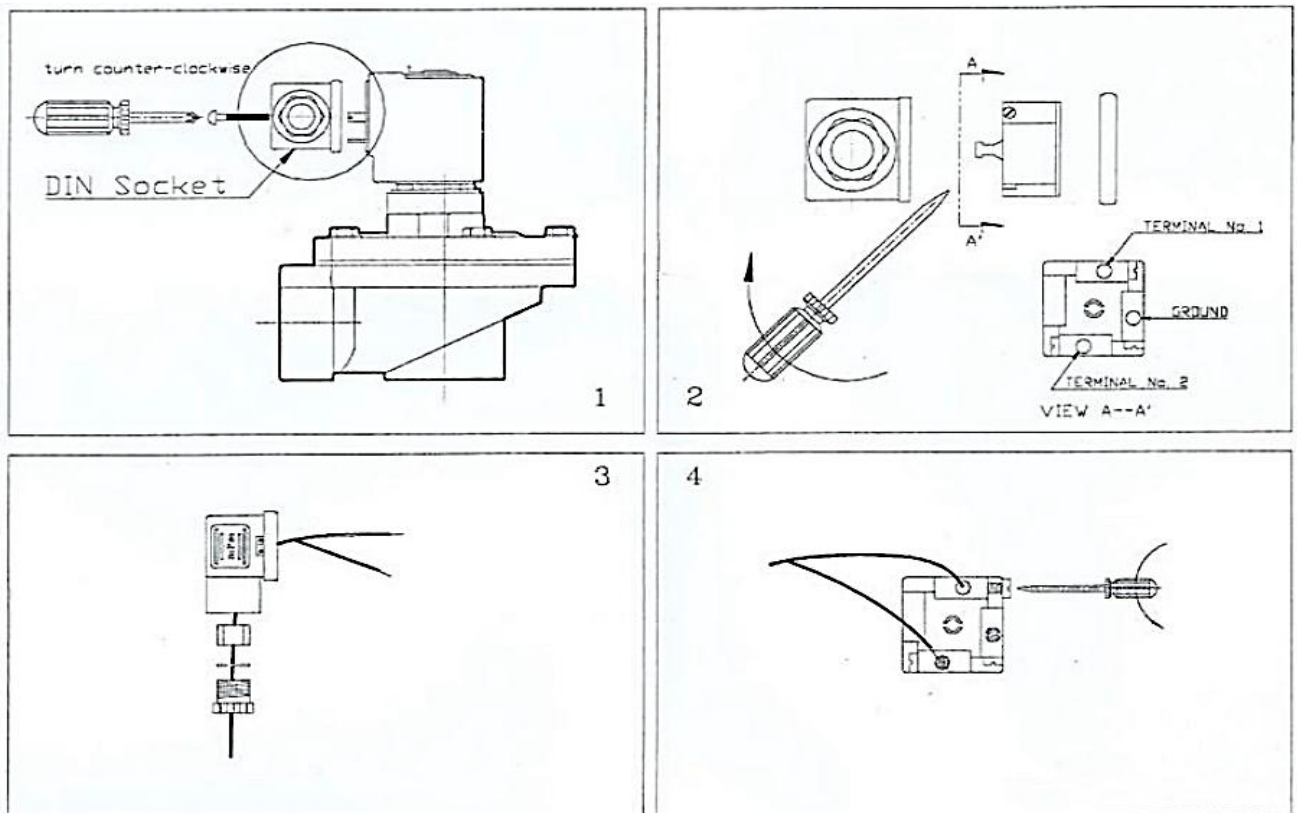



 DIN socket has three contacts, that is, exposing two contacts 1 & 2 and third is earth.

1.3.2 The method of terminal wiring

	<h2>CAUTION</h2>	<p>Before connecting electric power, electric wiring is conducted.</p>
---	------------------	--

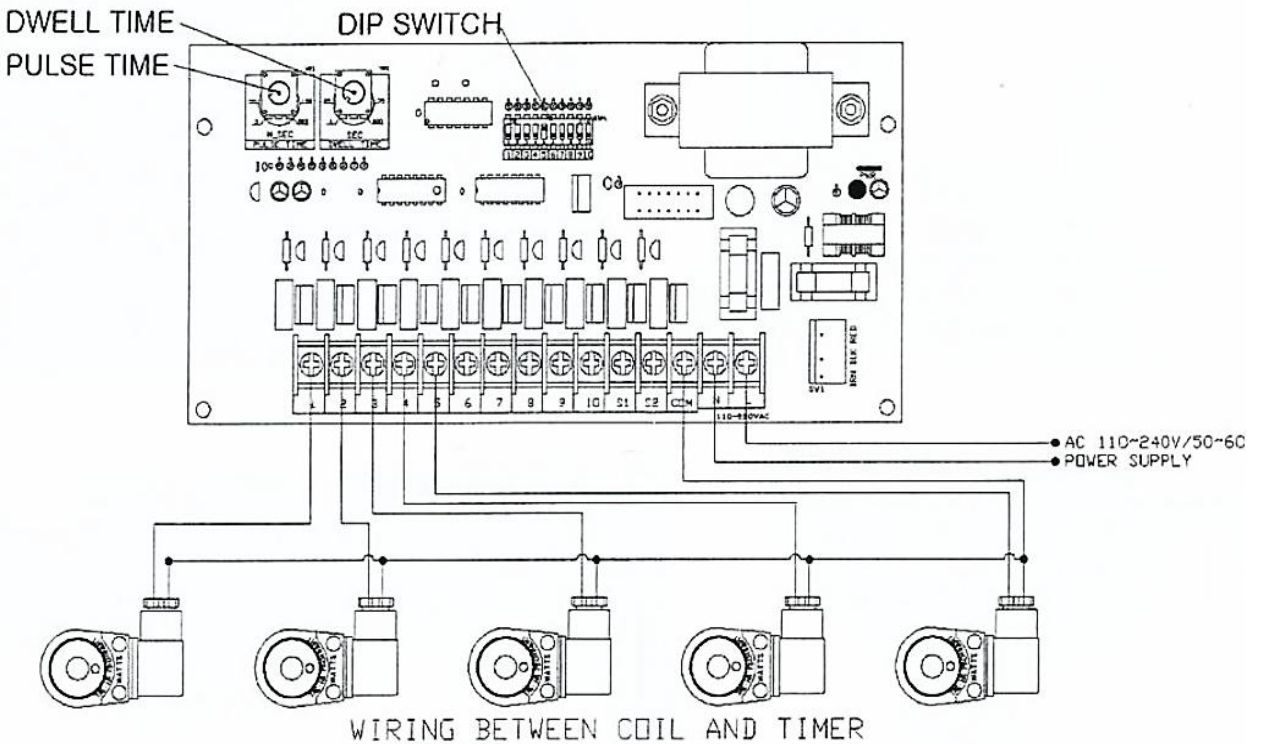
- 1) See diagram-regarding the terminal wiring between the Pulse Valve coil and Timer.
- 2) Connect L,N for the power supply.



	<h2>DANGER</h2>	<p>Be sure to turn off the power supply switch before connection of the terminal wiring.</p>
---	-----------------	--

For the power supply, check the voltage rating and current rating as specified in the part list for your product.

1.4 Timer Setting

After opening Timer cover, set up it as following figure.



DANGER

Before opening the cover, electrical supply must be disconnected.

1.4.1 Timer Works

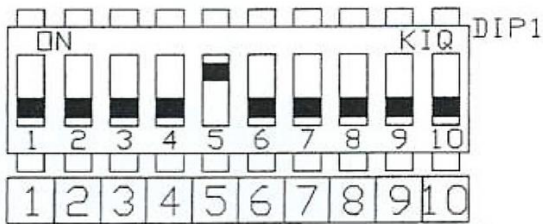

1) Push a DIP S/W number up as many as Pulse Valve quantity.
 Ex) If you have 5 Pulse Valves, push up a DIP S/W number '5' on the PCB written

2) Adjust Dwell Time.

Ex) Dwell Time Range is 1-99Sec. Adjust dwell time that you want turning dial.

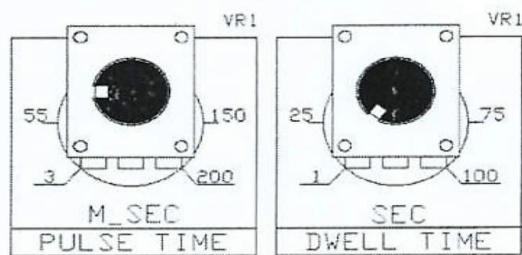

3) Adjust Pulse Time.

Ex) Pulse Time Range is 0.01-0.5Sec. Adjust pulse time that you want turning dial.

1.4.2 Supply of Power source

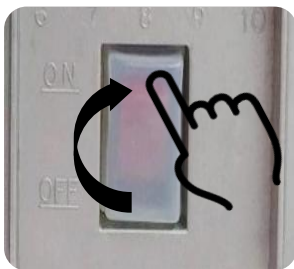

Turn on the power S/W as following figure.

Check switch lamp for lighting.

1.4.3 Operation Check



Make sure that pulse valves are operated normally as LED Lamp and sound.

If LED Lamp is lighted in sequence and you hear the sound If moving pole with a “click”, it is normal state.

PRODUCT



PRODUCT

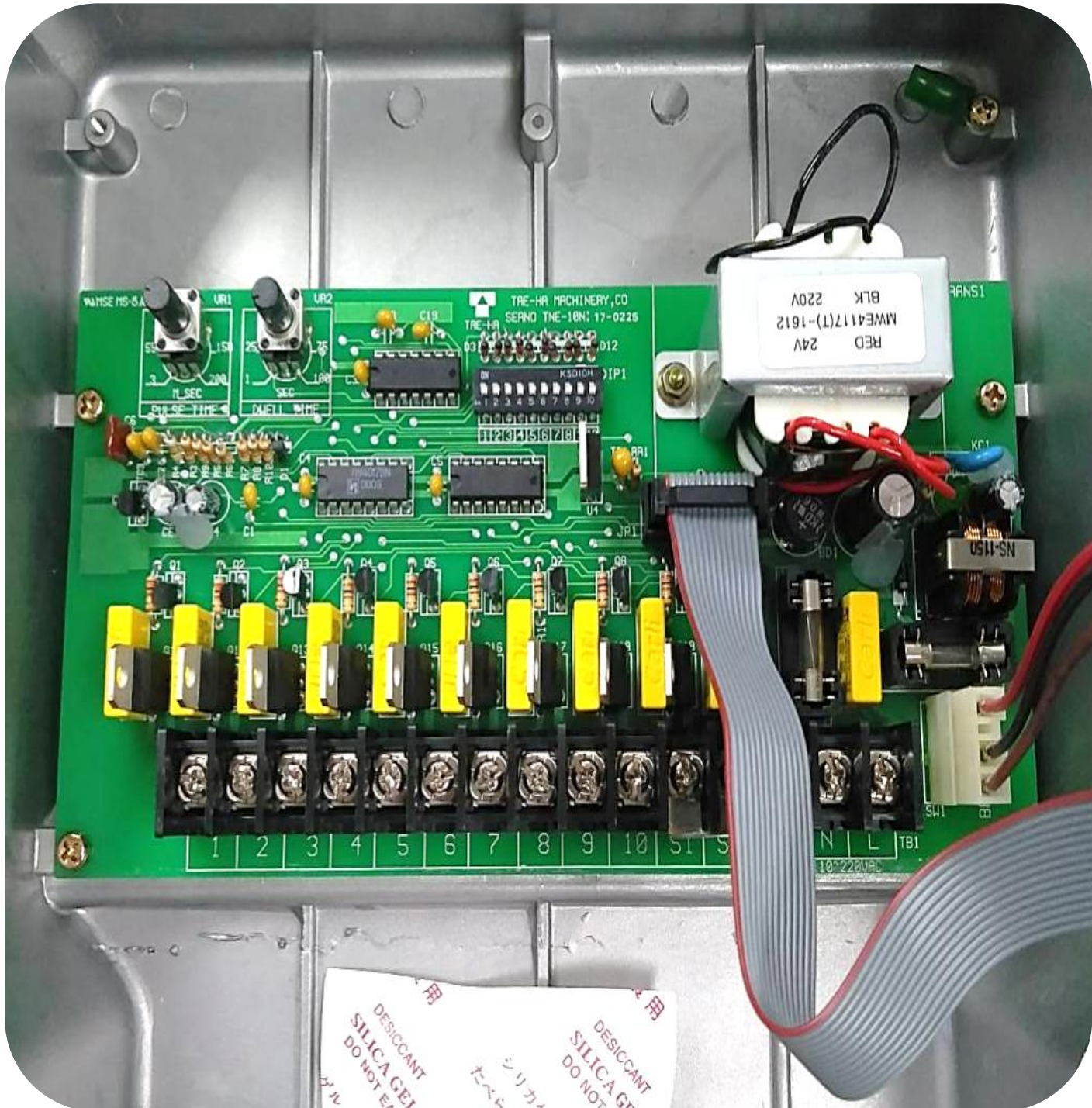

DESICCANT
SILICA GEL
DO NOT EXPOSE
シリカゲル
乾燥剤
シリカゲル
乾燥剤
DESICCANT
SILICA GEL
DO NOT EXPOSE
シリカゲル
乾燥剤

PRODUCT

